

Reus//170/17

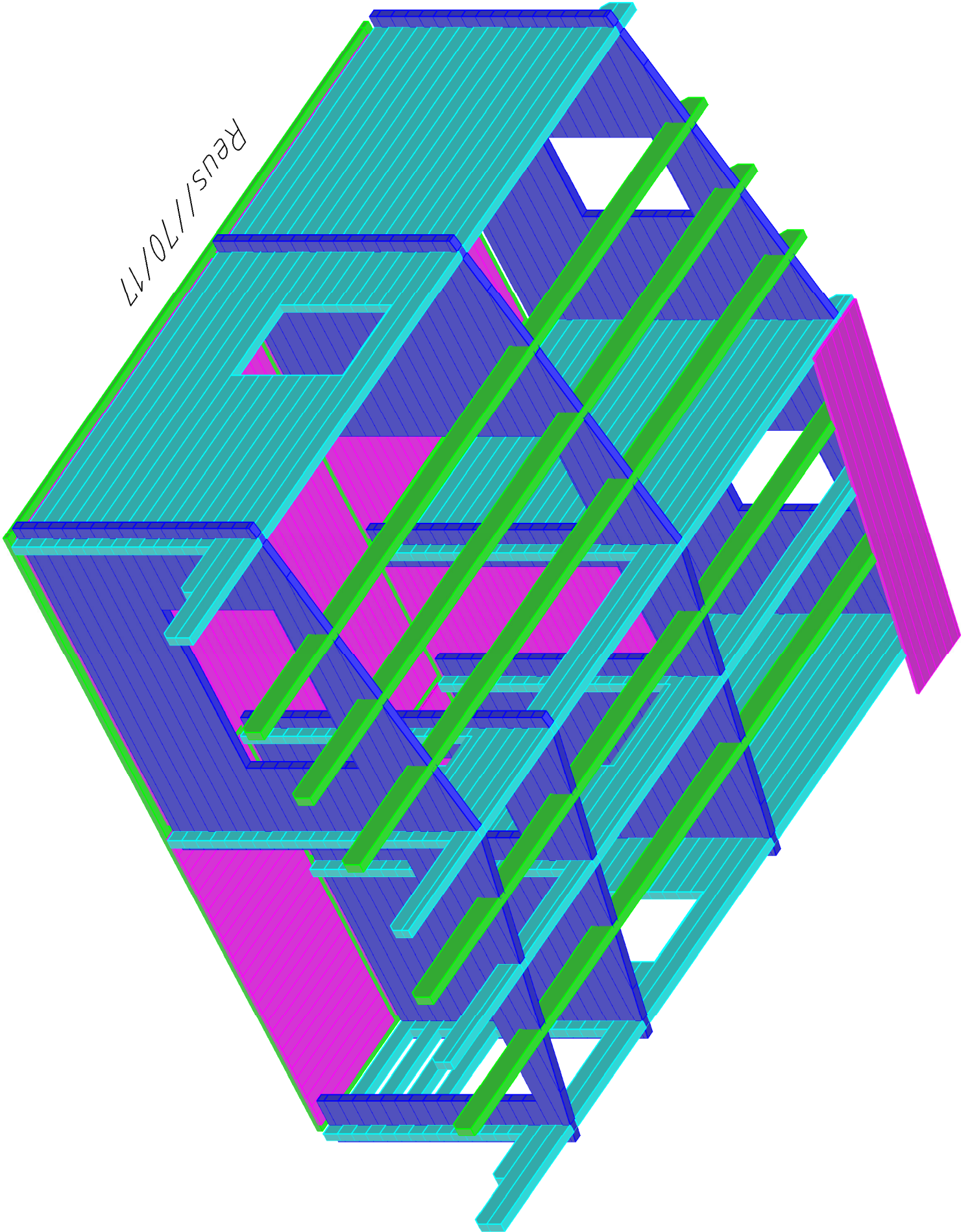

Grundplan

Reus // 70 // 17

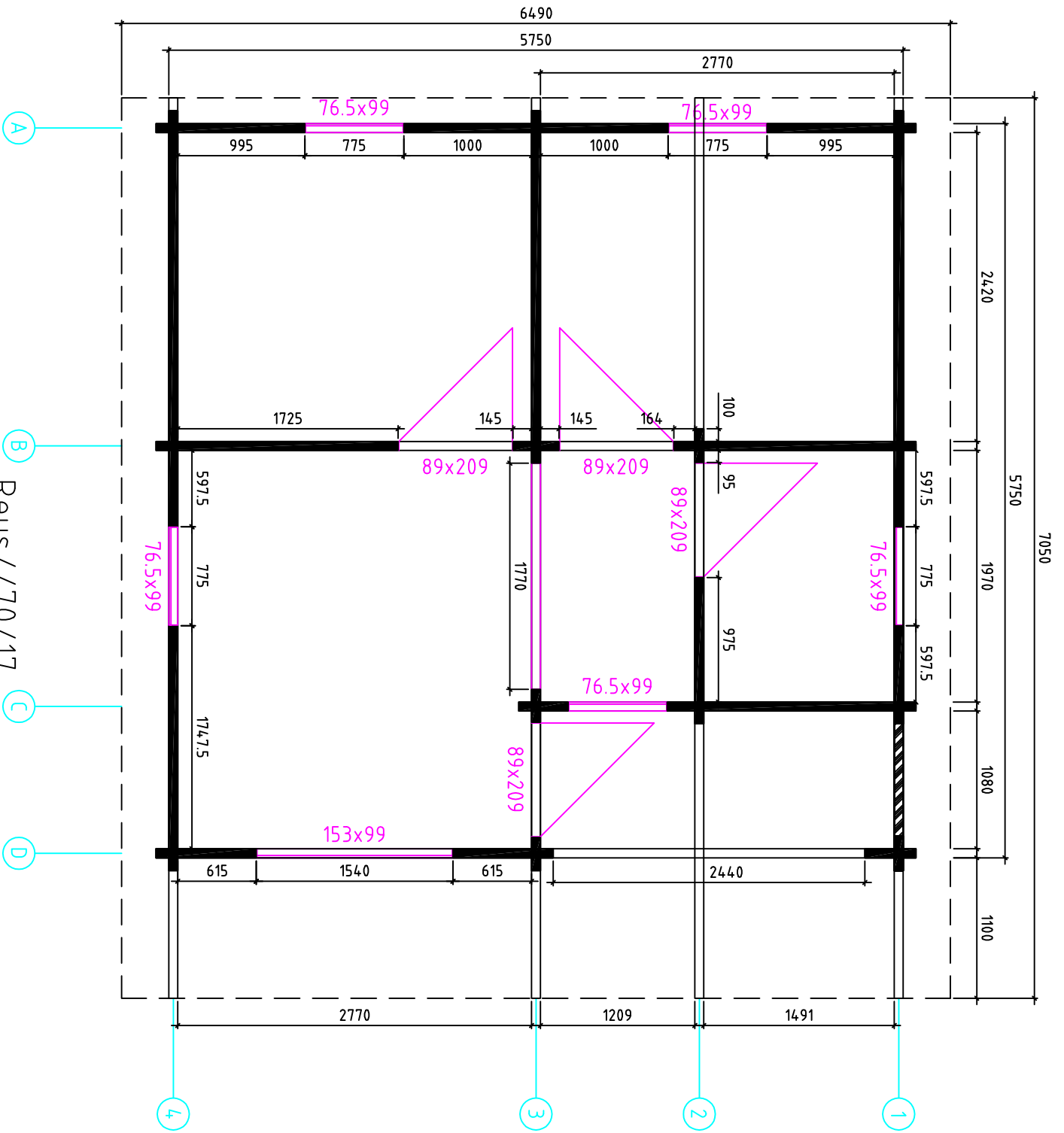

Schrauben
6x150

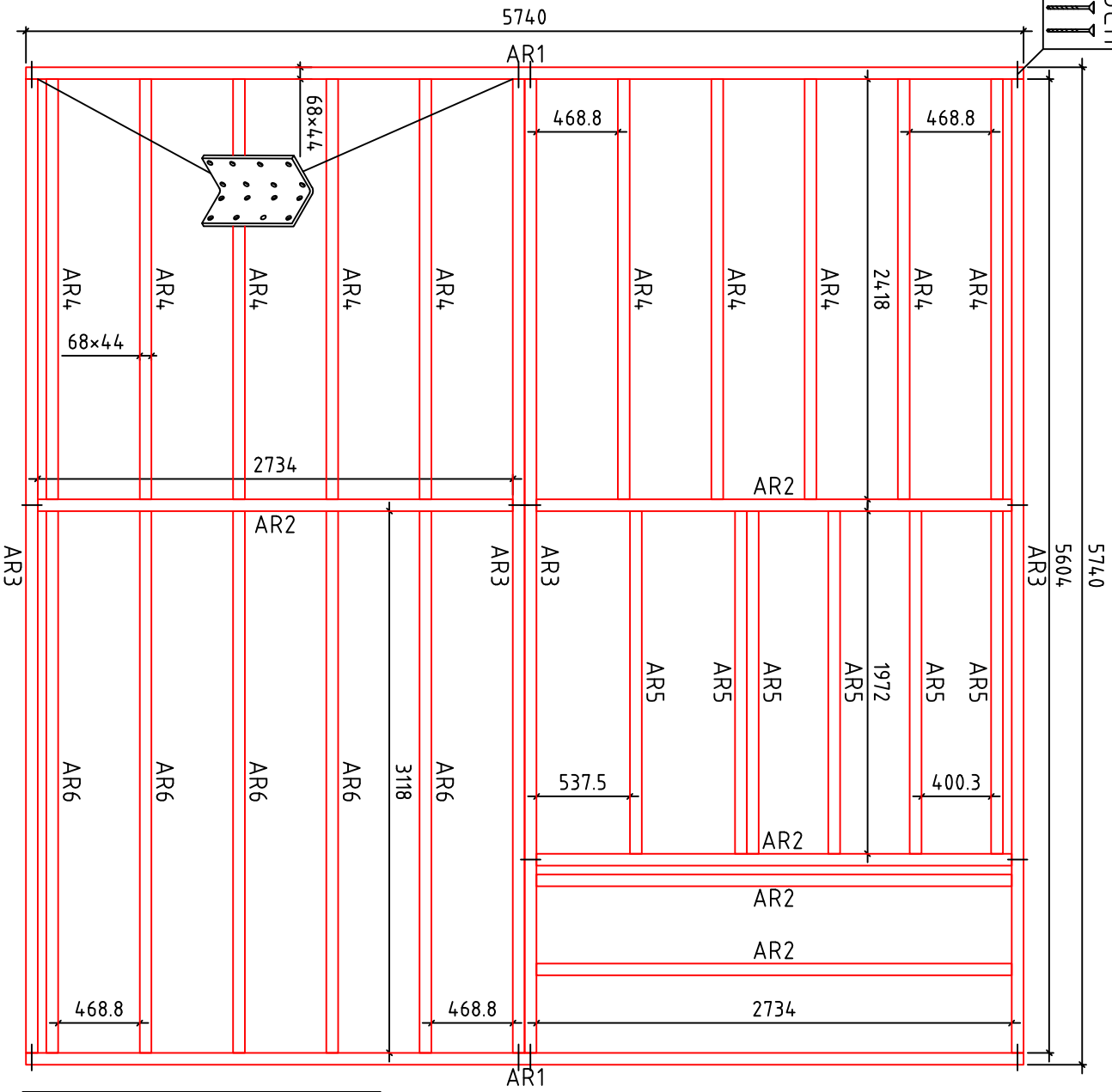

Reus // 70 / 17
Fundament

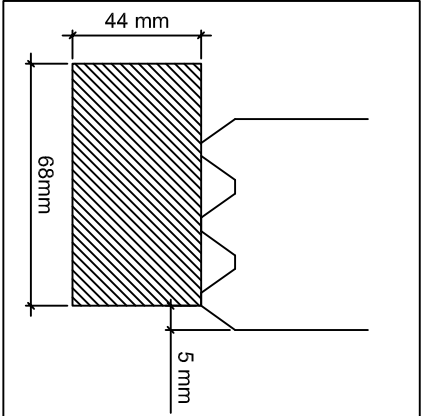

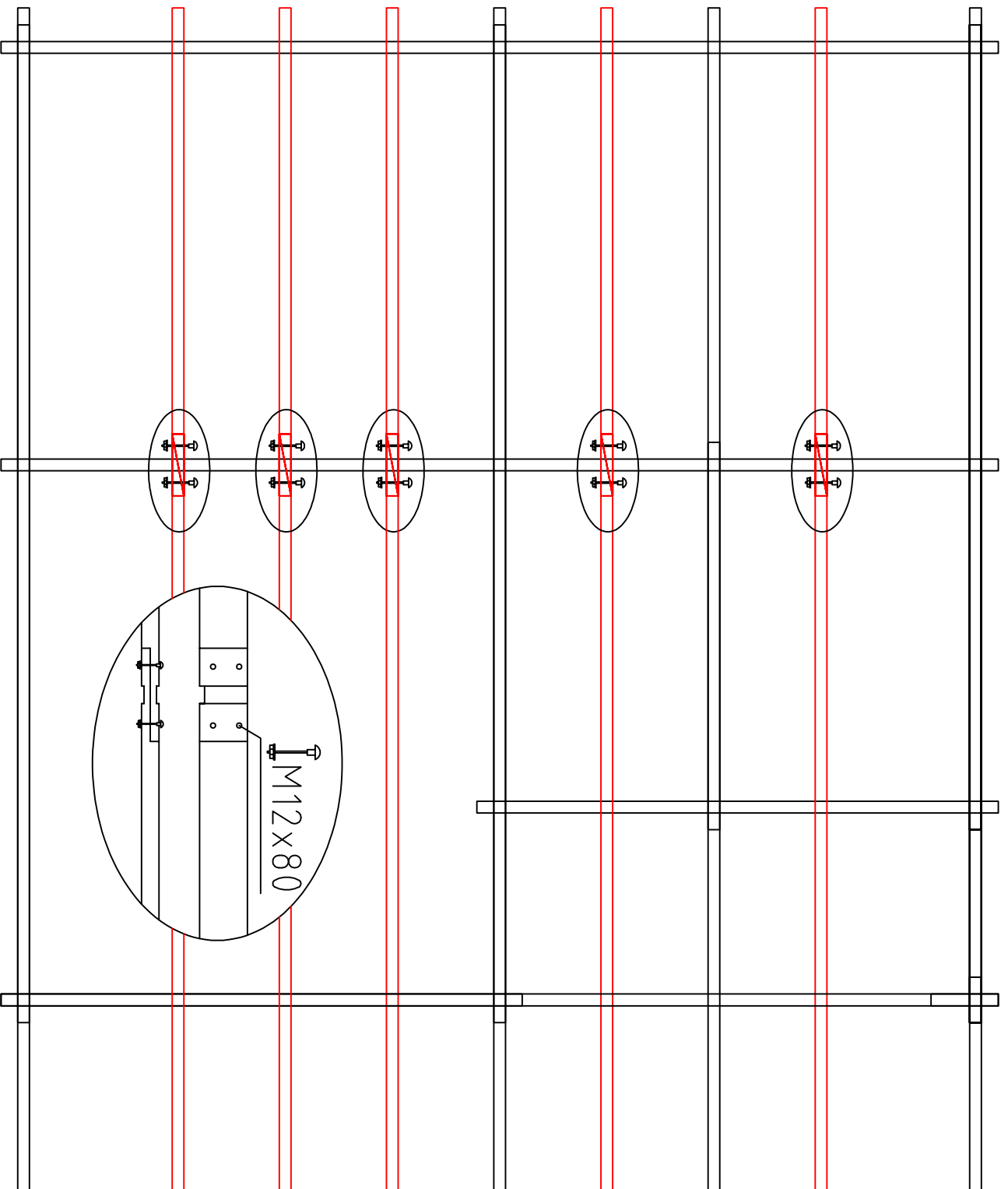

Reus // 70 // 17

Dachbalken

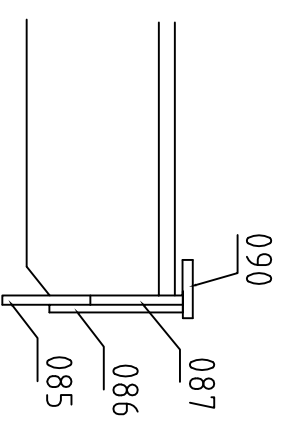
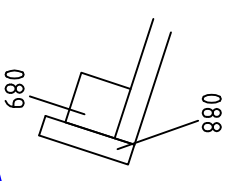

Wand D

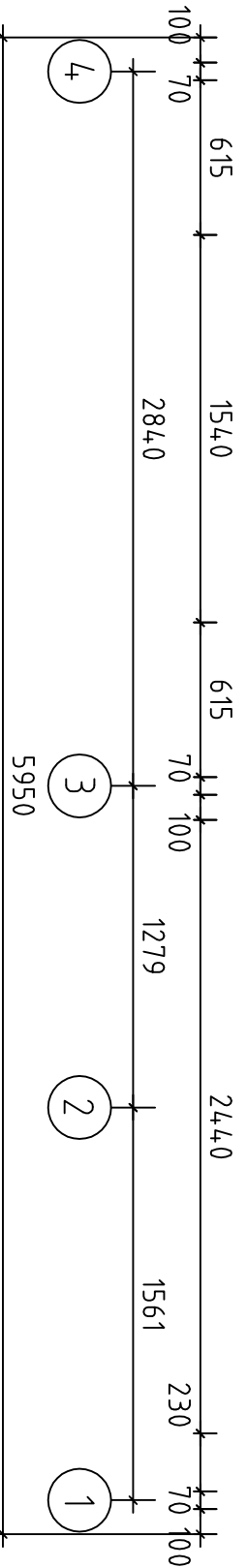
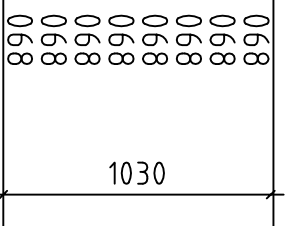
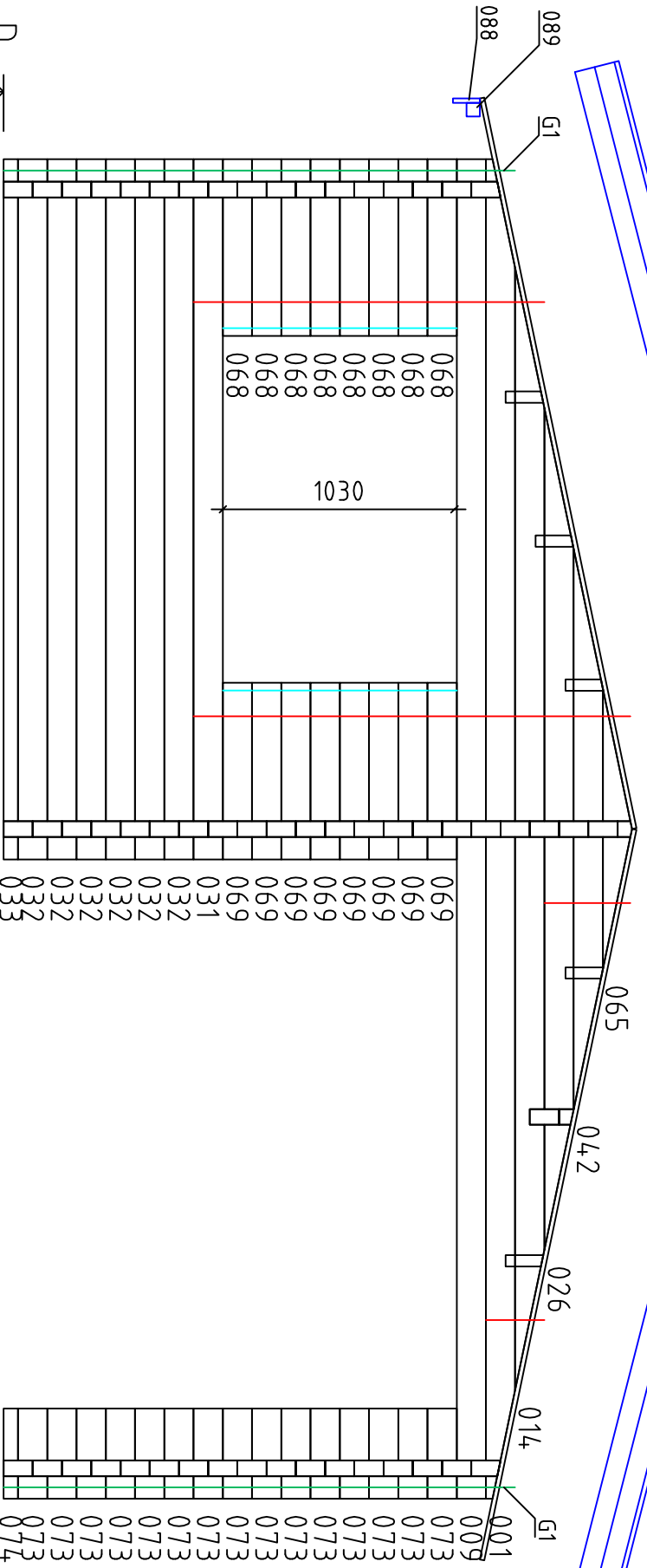

Reus//70//17

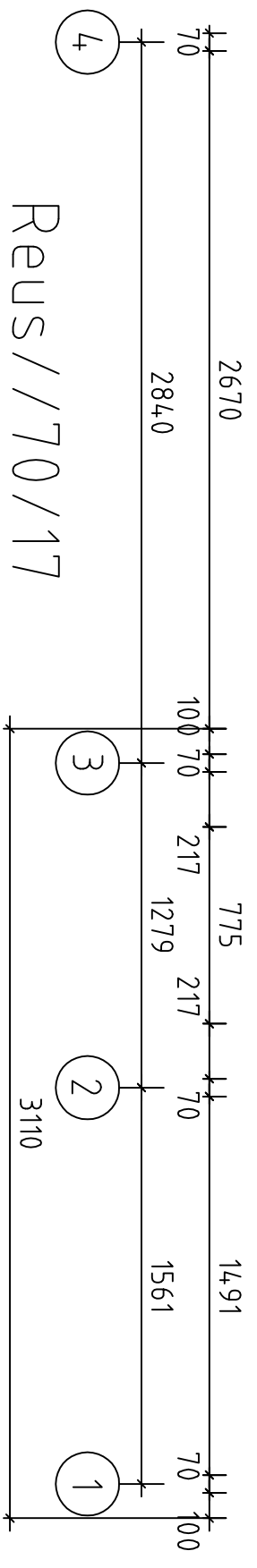
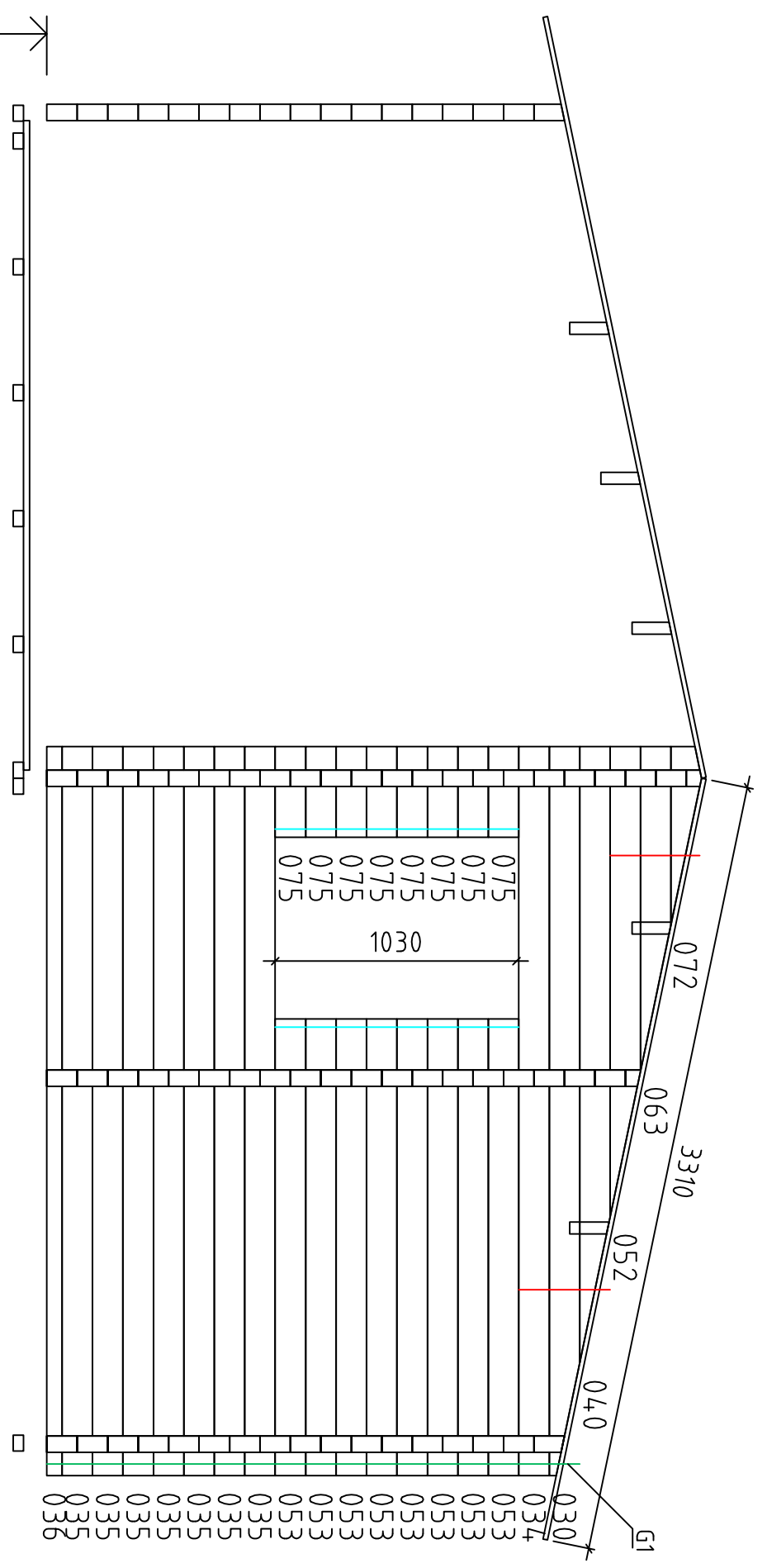

Reus // 70 // 17

Wand C

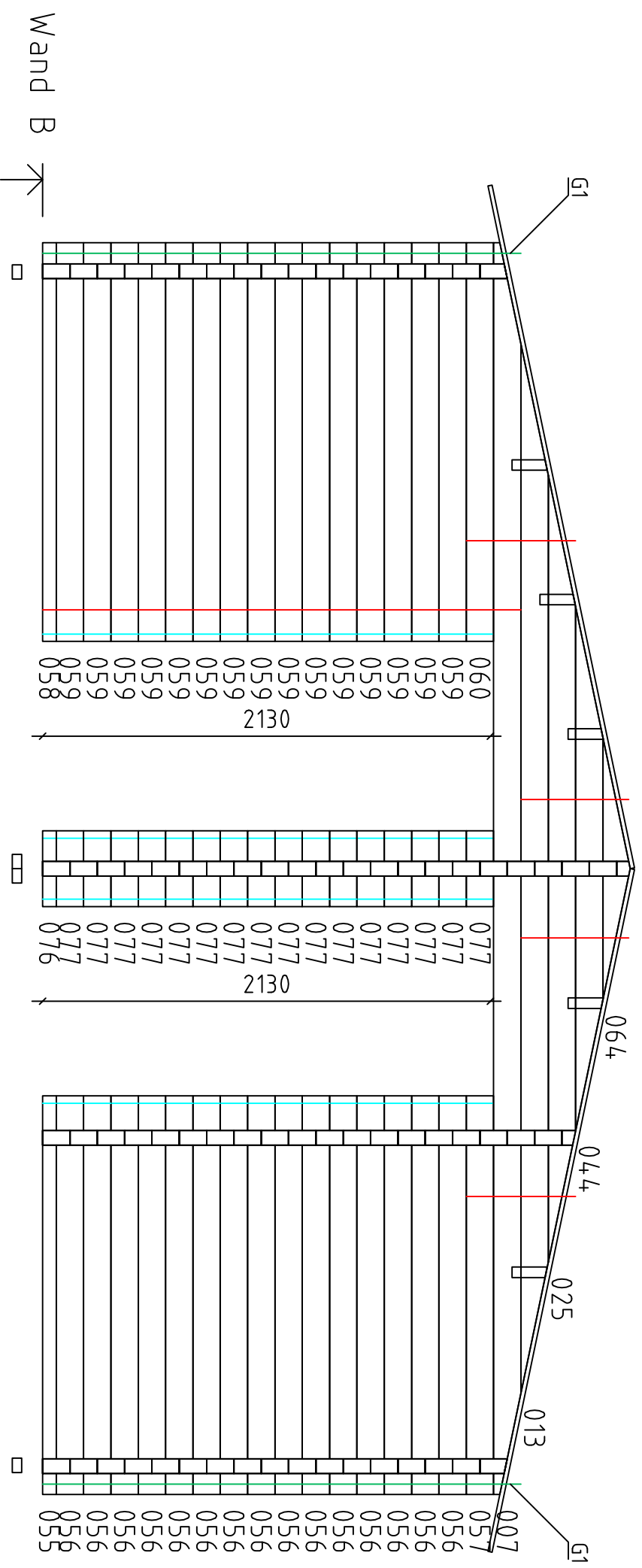

Reus // 70 / 17

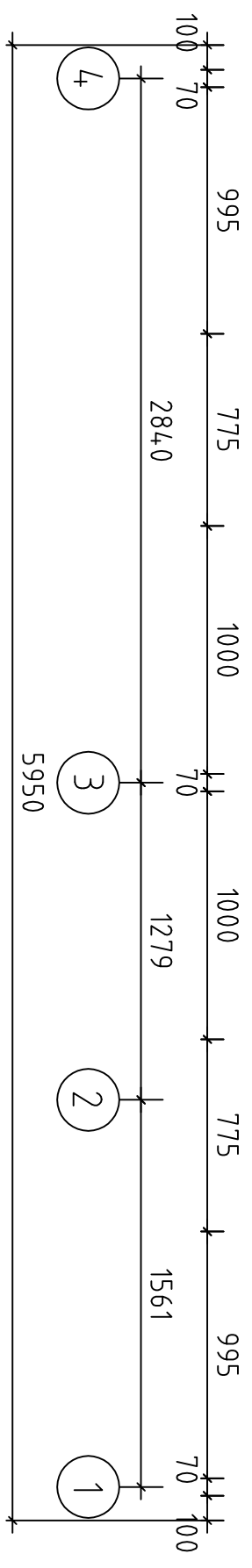
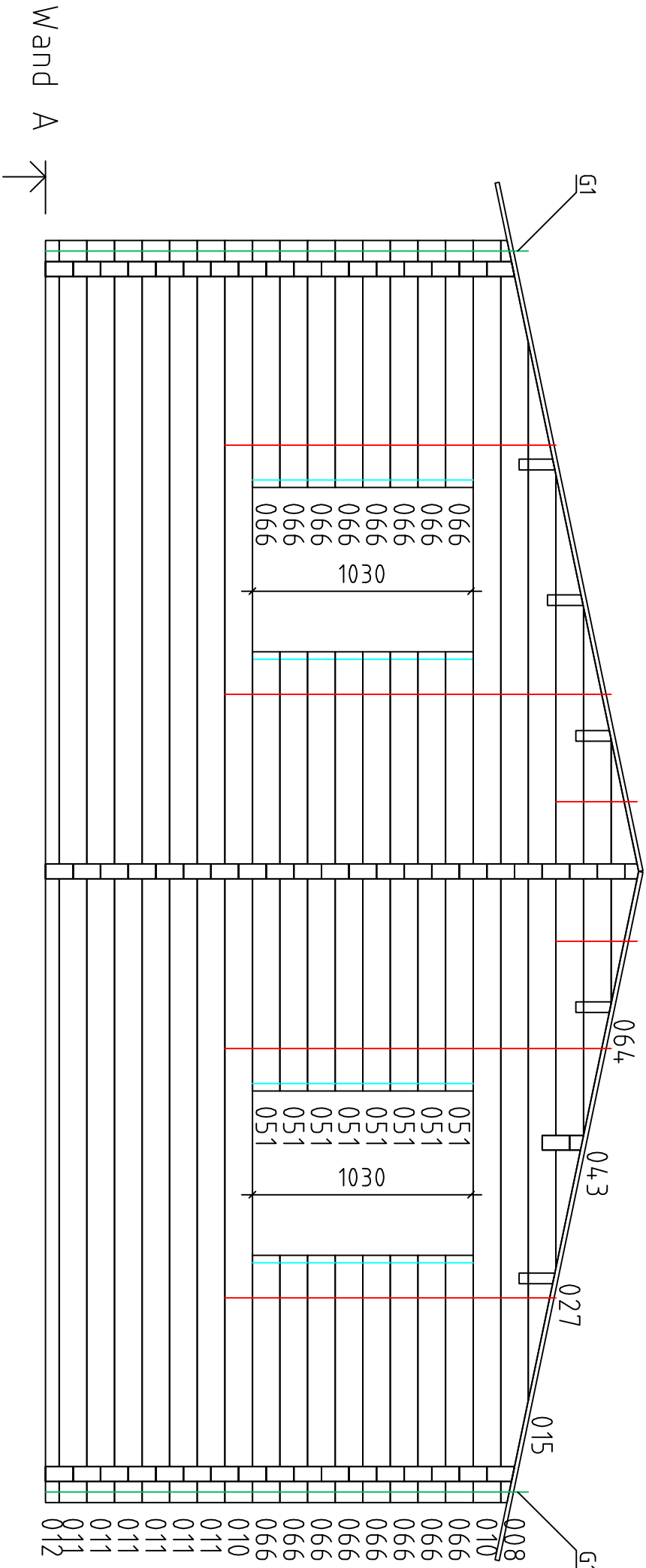

Reus // 70 // 17

- 008
- 010
- 066
- 066
- 066
- 066
- 066
- 066
- 066
- 066
- 066
- 010
- 011
- 011
- 011
- 011
- 011
- 011
- 012

Wand 1 ↗

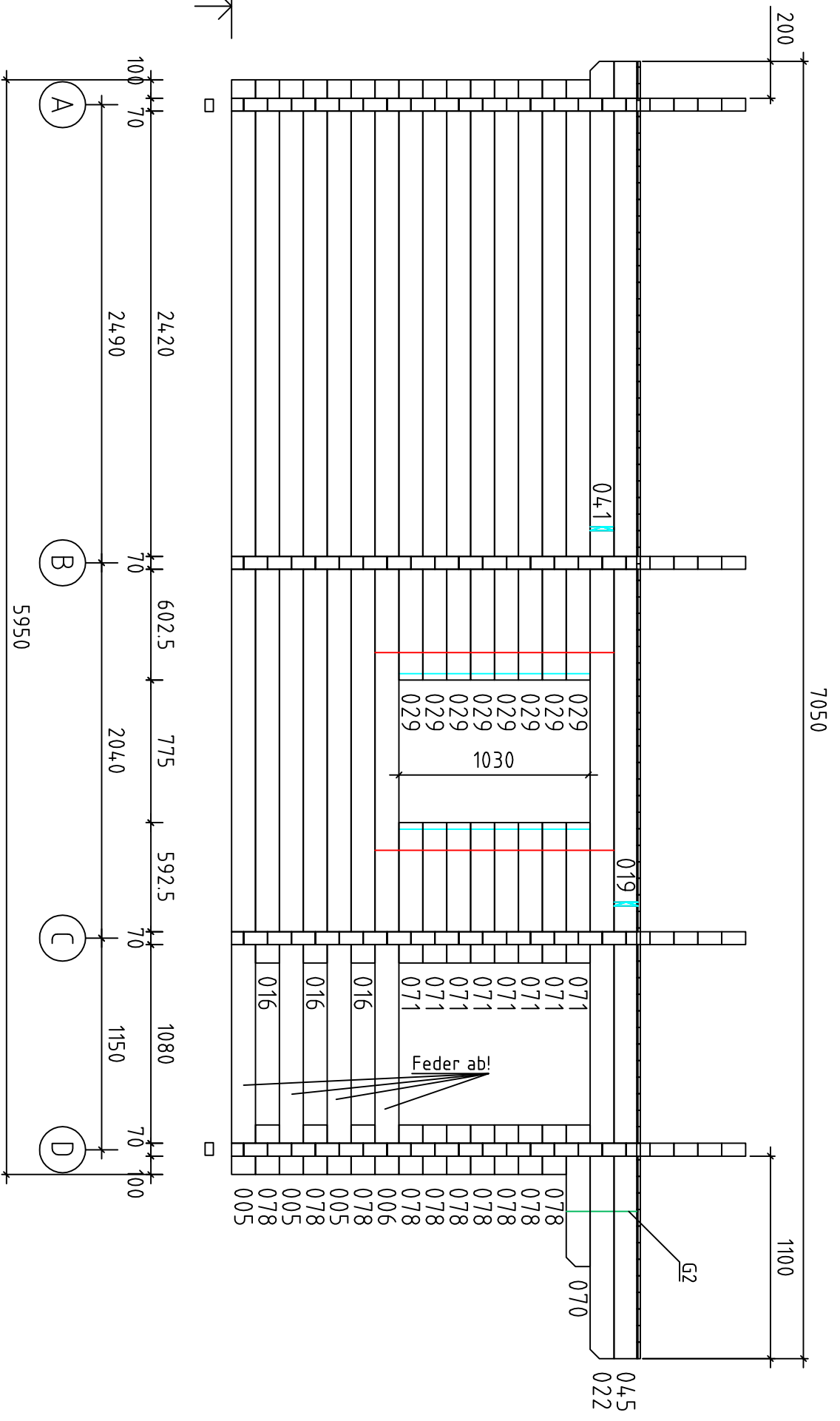

Reus//70/17

Wand 2

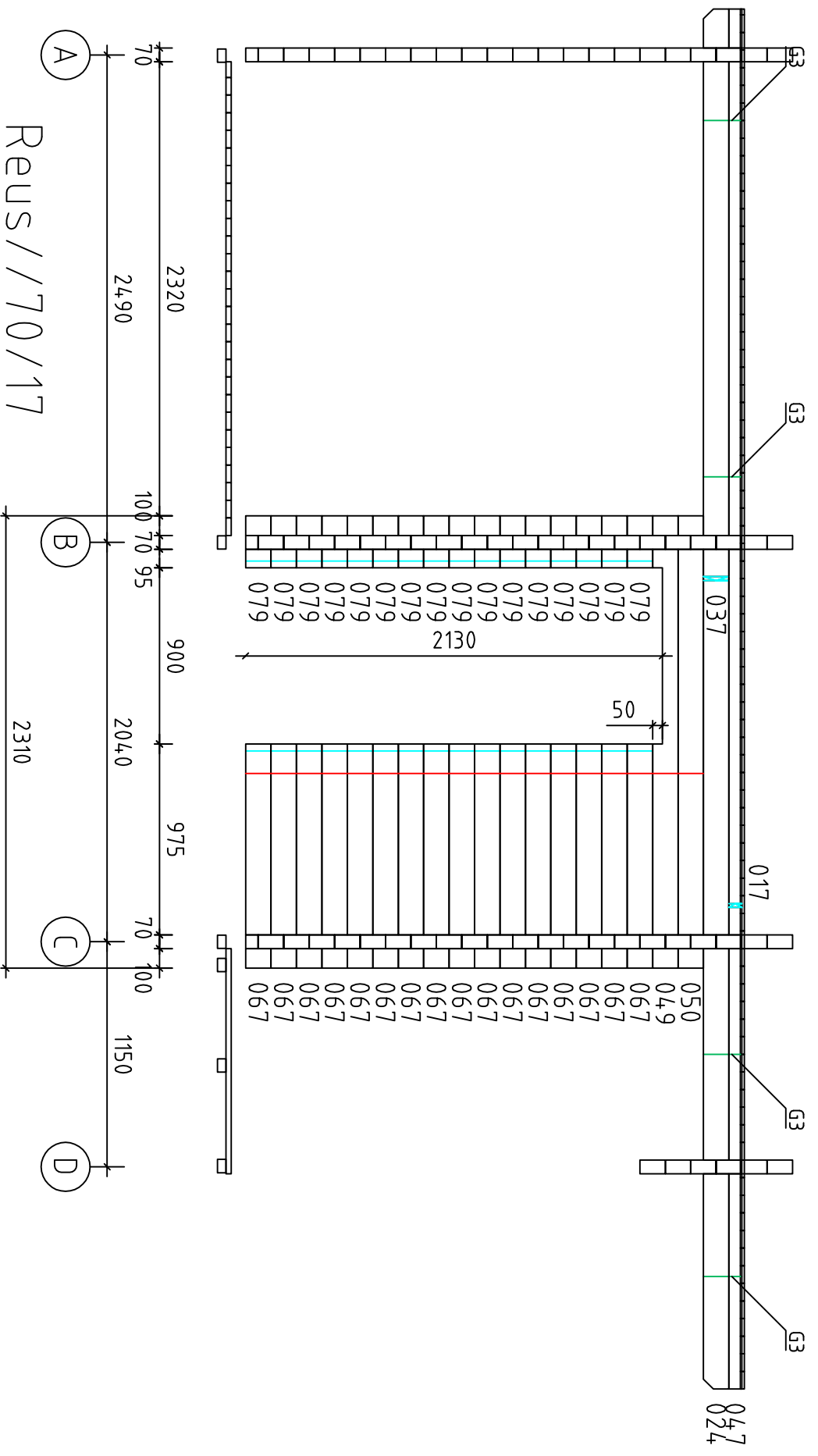

Wand 3 ↗

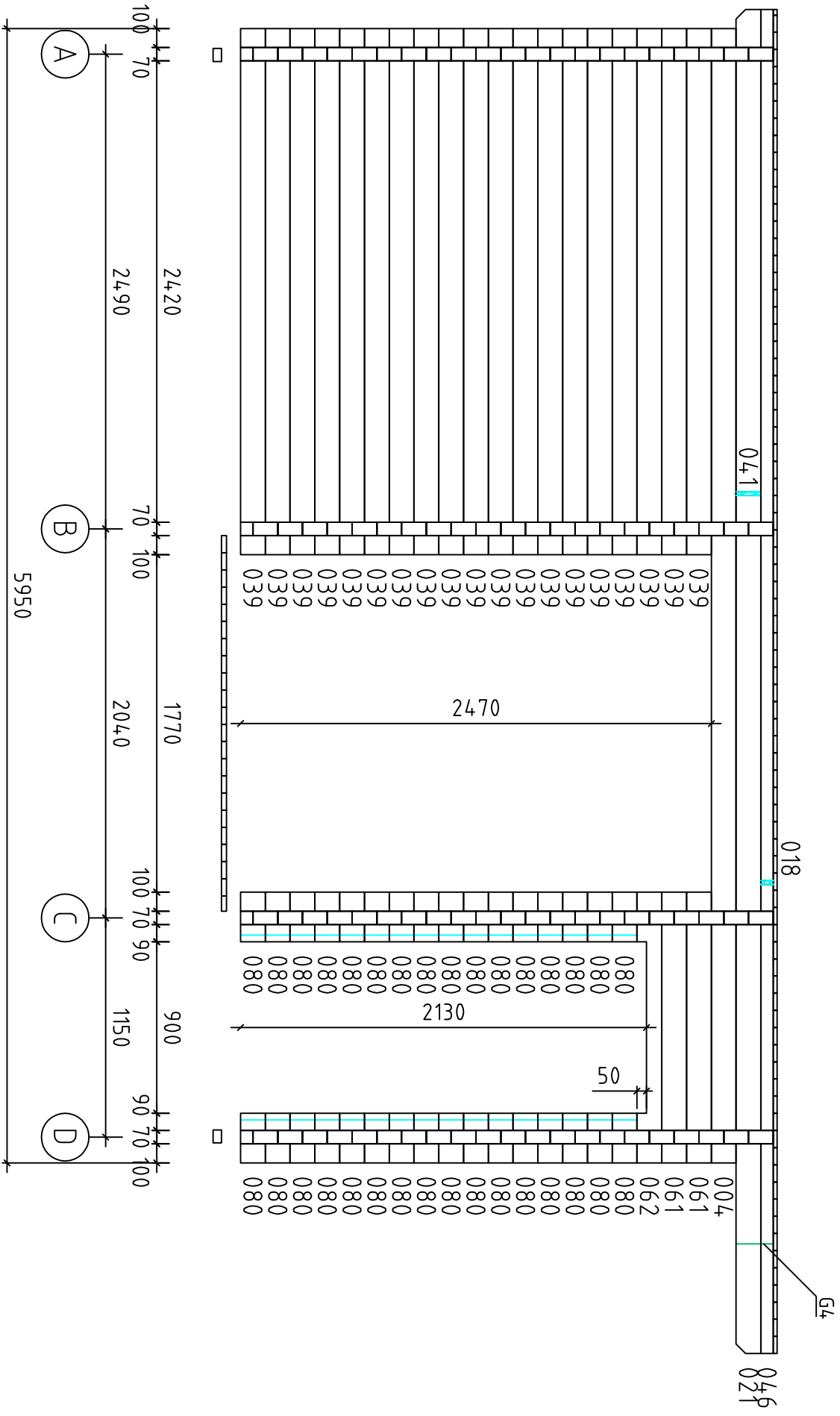



Reus // 70 // 17

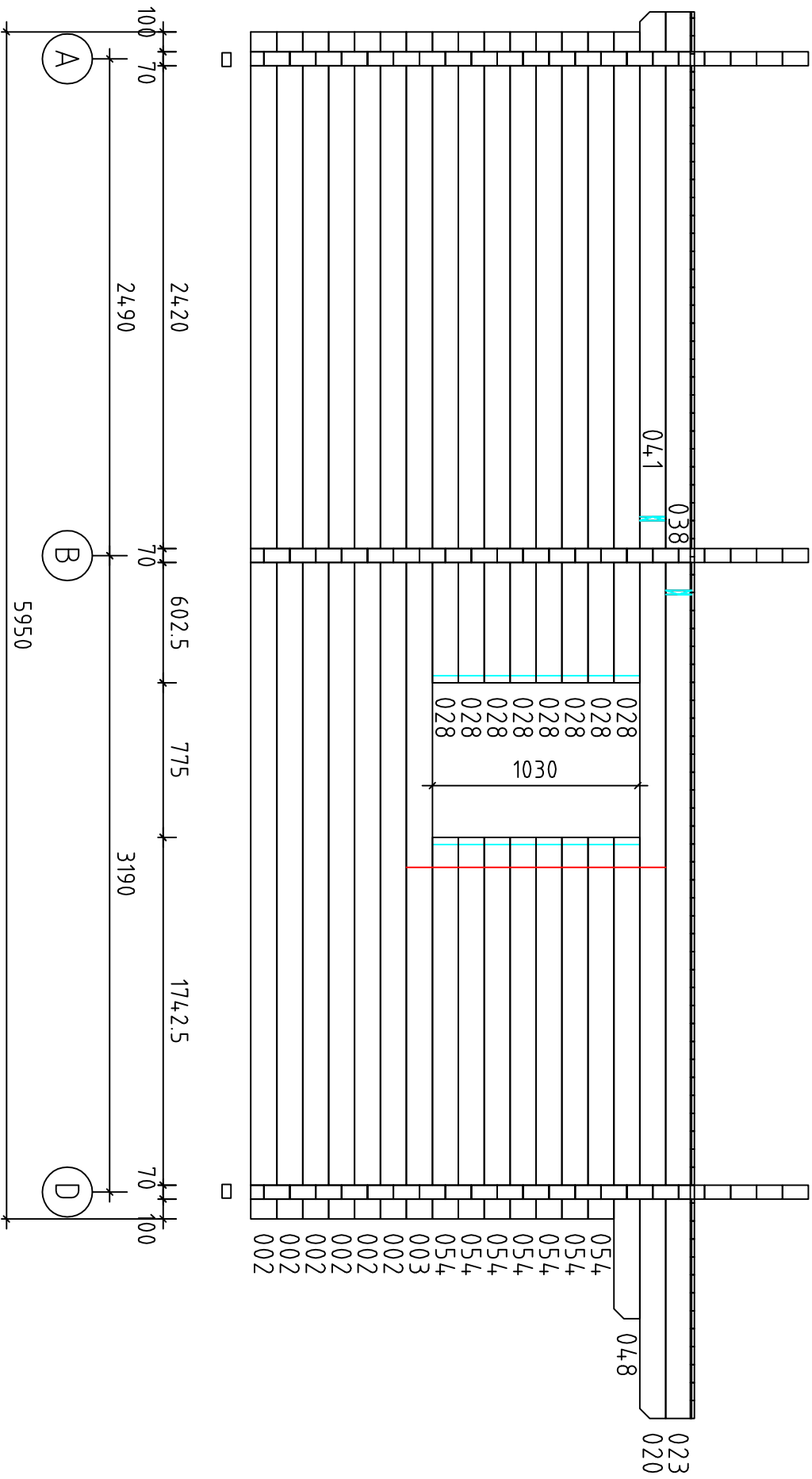



Wand 4 ↗

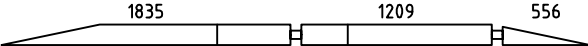
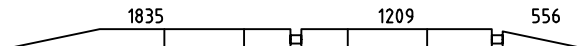
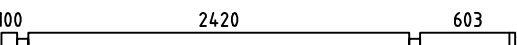
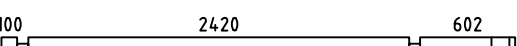
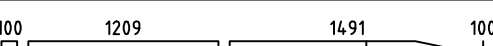
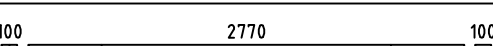
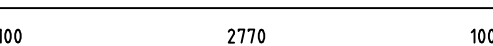
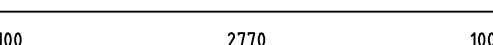
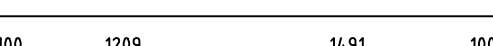
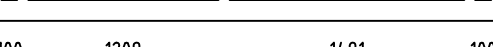
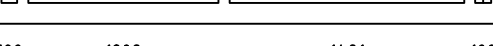
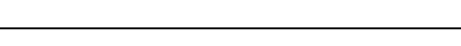
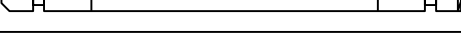
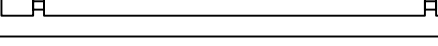
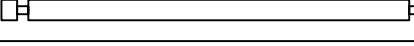
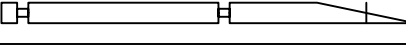
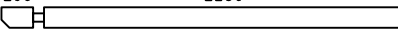
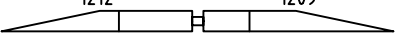
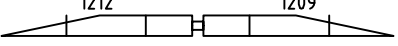
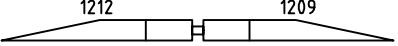
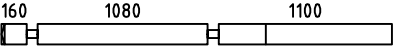

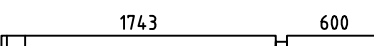
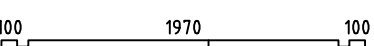

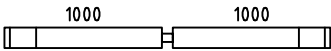
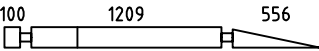
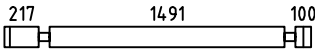
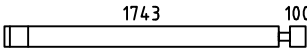
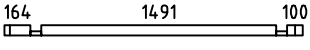
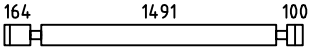
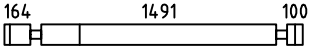
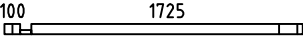
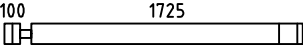
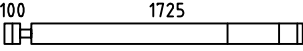
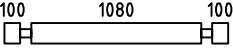
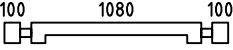
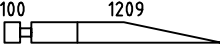
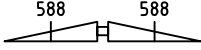
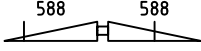
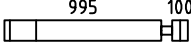
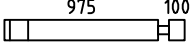
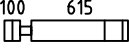
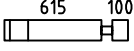
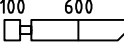
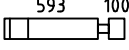
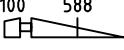

















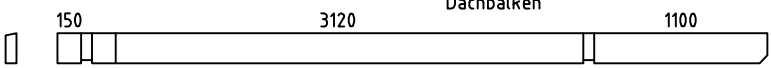
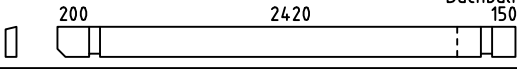
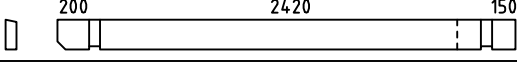

Reus // 70 // 17

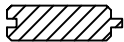
Pos	Reus//70/17	ST	F (mm)	L (mm)
001		1	70x130	5950
002		6	70x130	5950
003		1	70x130	5950
004		1	70x130	5950
005		3	70x130	5950
006		1	70x130	5950
007		1	70x130	5950
008		1	70x130	5950
009		1	70x130	5950
010		2	70x130	5950
011		6	70x130	5950
012		1	70x65	5950
013		1	70x130	4987
014		1	70x130	4987
015		1	70x130	4987
016		3	70x130	4800
017		1	70x66	4590
018		1	70x65	4590
019		1	70x130	4590
020		1	70x130	4520
021		1	70x130	4520
022		1	70x130	4520
023		1	70x130	4150
024		1	70x130	4150
025		1	70x130	3740

Pos	Reus//70/17	ST	F (mm)	L (mm)
026		1	70x130	3740
027		1	70x130	3740
028		8	70x130	3263
029		8	70x130	3262
030		1	70x130	3110
031		1	70x130	3110
032		6	70x130	3110
033		1	70x65	3110
034		1	70x130	3110
035		7	70x130	3110
036		1	70x65	3110
037		1	70x130	2920
038		1	70x130	2920
039		19	70x130	2760
040		1	70x130	2628
041		3	70x130	2550
042		1	70x130	2491
043		1	70x130	2491
044		1	70x130	2491
045		1	70x130	2480
046		1	70x65	2480
047		1	70x66	2480
048		1	70x130	2413
049		1	70x130	2310
050		1	70x130	2310

Pos	Reus//70/17	ST	F (mm)	L (mm)
051		8	70x130	2070
052		1	70x130	2005
053		8	70x130	1948
054		7	70x130	1913
055		1	70x65	1895
056		15	70x130	1895
057		1	70x130	1895
058		1	70x65	1895
059		15	70x130	1895
060		1	70x130	1895
061		2	70x130	1420
062		1	70x130	1420
063		1	70x130	1379
064		2	70x123	1247
065		1	70x123	1247
066		16	70x130	1165
067		16	70x130	1145
068		8	70x130	785
069		8	70x130	785
070		1	70x130	770
071		8	70x130	763
072		1	70x123	758
073		15	70x130	400
074		1	70x65	400
075		8	70x130	387

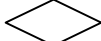
Pos	Reus//70/17			ST	F (mm)	L (mm)
076	145 145 			1	70x65	360
077	145 145 			16	70x130	360
078	100100 			10	70x130	270
079	100 95 			16	70x130	265
080	100 90 			32	70x130	260
AR1	Fundamentbalken 		Impr.	2	68x44	5740
AR3	Fundamentbalken 		Impr.	4	68x44	5604
AR6	Fundamentbalken 		Impr.	5	68x44	3118
AR2	Fundamentbalken 		Impr.	5	68x44	2734
AR4	Fundamentbalken 		Impr.	10	68x44	2418
AR5	Fundamentbalken 		Impr.	6	68x44	1972
PR2	 Dachbalken 150 1970 1080 1100			2	70x190	4510
PR4	 Dachbalken 150 3120 1100			3	70x190	4510
PR3	 Dachbalken 200 2420 150			3	70x190	2910
PR1	 Dachbalken 200 2420 150			2	70x190	2910

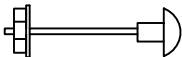
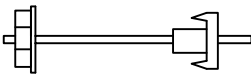
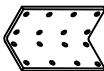
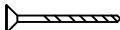
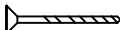
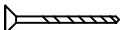
Pos	Reus//70/17		ST	F (mm)	L (mm)	
081	Fussbodenbretter					
			22	90x26	4049	
			67	90x26	2770	
			22	90x26	1491	
082	Terrassenbretter		Impr.	31	90x26	1150
083	Dachbretter			158	90x20	3310
084	Abdeckleiste				20x40	50m
085	Giebelbretter			4	20x120	3610
086	Giebelbretter			4	20x90	3610
087	Giebeldeckbretter			8	20x70	3610
088	Traufenbrett			4	20x90	3675
089	Träger für traufenbrett			4	50x50	3675
090	Giebelsegment			2		
091	Dübel			178		
091	Bolzen für Dachbalken			20	M12	80
G1	Gewindestift12			7		2215
G2				1		420
G3				4		225
G4				1		225
KMPL.	Vinkel			40	40x40x40	
	Schrauben für Vinkel 4x40			320		
	Schrauben für Fundament 6x150			40		
	Nagel 2,5x60 (külM ZN) (Fussboden und Dach)			6kg		
	Schrauben für Abdeckleiste 4x40			90		
Kood	Materjal	File	trükk.dwg	Leht	4/5	

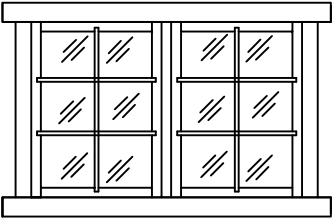
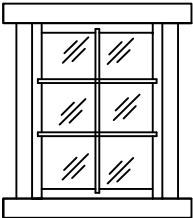
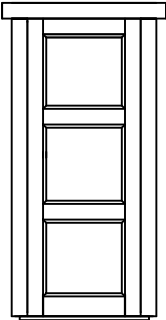
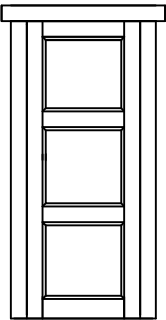
Pos	Reus//70/17	ST	F (mm)	L (mm)
F1	<p>Fenster 1530x990</p>  <p>Tenderleiste 23x23x990=2st.</p>	1		
F2	<p>Fenster 765x990</p>  <p>Tenderleiste 23x23x990=10st.</p>		3R+2L	
T1	<p>Tür 890x2090</p>  <p>Tenderleiste 23x23x2040=2st.</p>	1R		
T2	<p>Tür 890x2090</p>  <p>Tenderleiste 23x23x2090=4st. Tenderleiste 23x23x2040=2st.</p>		1L+2R	
Kood	Materjal	File	trükk.dwg	Leht 5/5